

Data Sheet



Article number: 025798400030

Description: Norma Connect pipe coupling
GRIP E W2 Ø=30,7 NBR, 16 bar

Measures

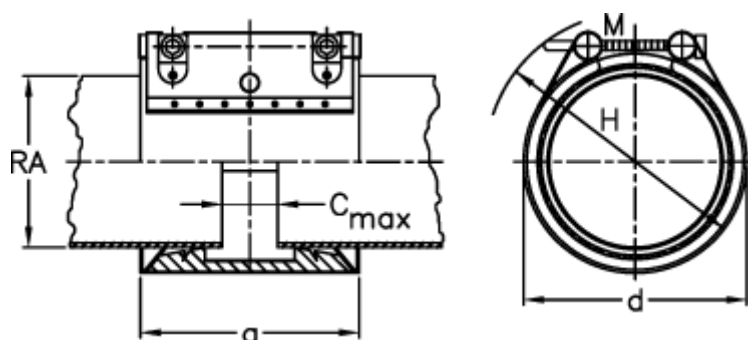

a = 67

C max with insertion band = 3

d = 50

H = 70

M (screw) = M8

Nominal pressure (bar) = 16

RA = 30

RA min-RA max = 28,6-30,5

Weight a piece = 0.4